

M=BUS Pro Fire Box

Ignites pyrotechnical devices such as airbags or seat belt pretensioners.

- | Support of 4 or 8 fire channels
- | Individually programmable timers
- | Operation independent from other M=BUS devices possible
- | Squib recognition
- | Mechanical and electrical interlock



TECHNICAL SPECIFICATIONS

Supported channels	4 or 8
Supply voltage	18...22 VDC
Power consumption	13 W
Trigger	Trigger-Bus (RS 485), 5V-TTL compatible; insulated 300 V
DC-Ignition	12 V, adjustable current: 0.1...8 A in steps of 0.1 A @ 1 Ω
Ignition energy	280 mJ
Ignition delay (set per software)	Min. 0.01 ms in steps of 0.01 ms
Ignition pulse duration (set per software)	Min. 0.1 ms in steps of 0.01 ms
Communication	IEEE 802.3 i/u Ethernet 10 Mbit/s / 100 Mbit/s
Battery capacity	2,200 mAh, 3.7 VDC (Lithium-Polymer) Yearly maintenance mandatory
Dimensions (L x W x H)	80 mm x 136 mm x 40 mm
Weight	4 channel: 522 g; 8 channel: 622 g
Operating temperature	0...50 °C
Shockproof	200 G @ 10 ms 1,000 G @ 1 ms
Humidity range	10...70 % RH

- Scope of supply**
- | M=BUS Pro Fire Box
 - | Connecting cable for M=BUS Pro Ethernet Gateway (0.3 m)
 - | Connecting cable for power, network and trigger (0.3 m)
 - | Network cable, Western/Lemo (3 m)
 - | Power supply with cable (3 m)
 - | Safety connector
 - | Trigger switch

Required equipment | CrashSoft control software

- Options**
- | M=BUS Pro Mounting Rail
 - | M=BUS Pro UPS
 - | M=BUS Pro Mounting Plate

PIN ASSIGNMENT



Pin	Description	Pin	Description
1	+ for anode of the LED in the release connector	3	Release input via bridge in the release connector (fire only)
2	- for cathode of the LED in the release connector	4	Release input via bridge in the release connector (fire only)

Figure 1: Pin assignment release connector for fire or safe (socket view, device)

Use this plug: LEMO FGG.0B.304...

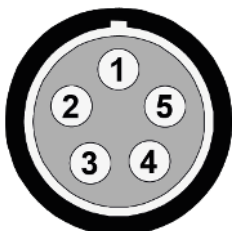

Pin	Description	Pin	Description
1	Fire In / Out -	4	Non-operating
2	Non-operating	5	Fire In +
3	Fire Out +: + connection of the ignition tablet		

Figure 2: Pin assignment ignition channel (socket view, device)

Use this plug: LEMO FGG.1B.305...

Current ramp-up time as a function of load resistance (Ohm) and selected current range (Ampere)

	With R = 1 Ω						With R = 10 Ω
Set current	1 A	2 A	3 A	4 A	5 A	6 A	1 A
∅ current ramp-up time per 1A	182 μs	68 μs	42 μs	31 μs	26 μs	21 μs	760 μs

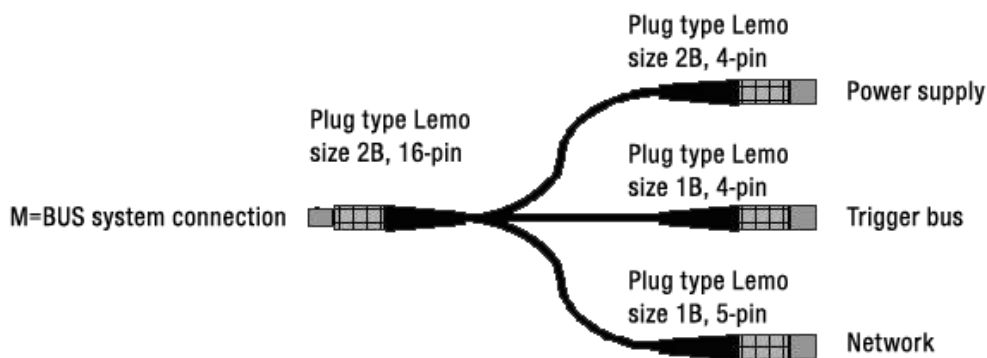
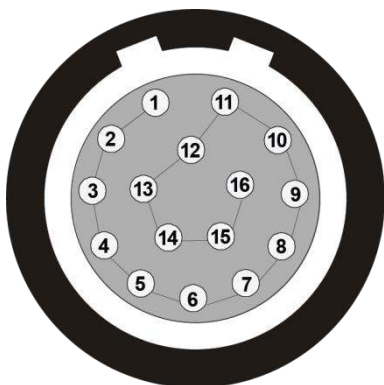

Figure 3: M=BUS Ethernet Gateway adapter



Pin	Description	Pin	Description
1	Network TX+	9	485 A
2	Network TX-	10	485 B
3	Network RX+	11	Supply +22 V
4	Network RX-	12	Supply +22 V
5	Trigger 5 V / 120 mA	13	Supply +22 V
6	Trigger Signal B	14	Ground
7	Trigger Signal A	15	Ground
8	Trigger Isolated Ground	16	Ground

Figure 4: M=BUS system connection (socket view, device)

Use this plug: LEMO FGC.2B.316...



Pin	Description	Pin	Description
1	Supply +22 V	3	485 A
2	Ground	4	485 B

Figure 5: Pin assignment power (socket view, cable)

Use this plug: LEMO FGG.2B.304...



Pin	Description	Pin	Description
1	Trigger 5 V / 120 mA	3	Trigger Signal A
2	Trigger Signal B	4	Trigger isolated ground

Figure 6: Pin assignment trigger bus (socket view, cable)

Use this plug: LEMO FGG.1B.304...

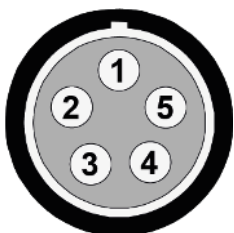

Pin	Description	Pin	Description
1	Network TX+	4	Network RX-
2	Network TX-	5	not connected
3	Network RX+		

Figure 7: Pin assignment network (socket view, cable)

Use this plug: LEMO FGG.1B.305...

TRIGGER BUS

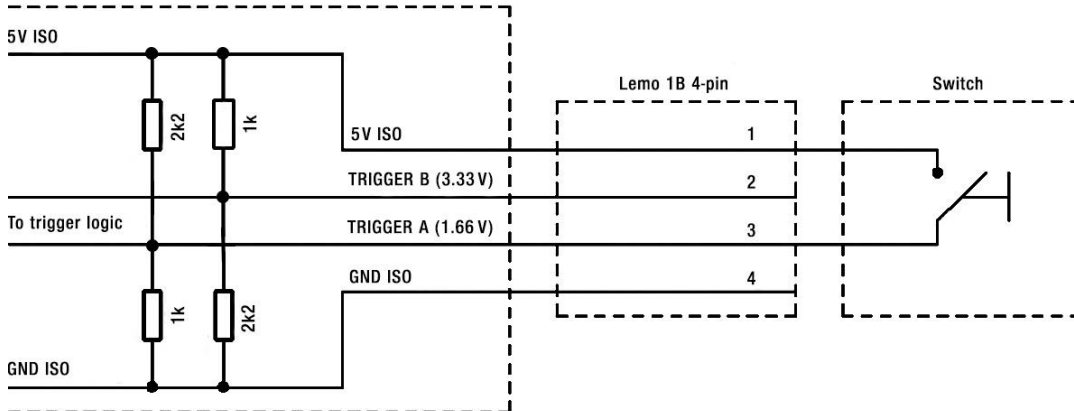

Figure 8: Schematic for trigger switch

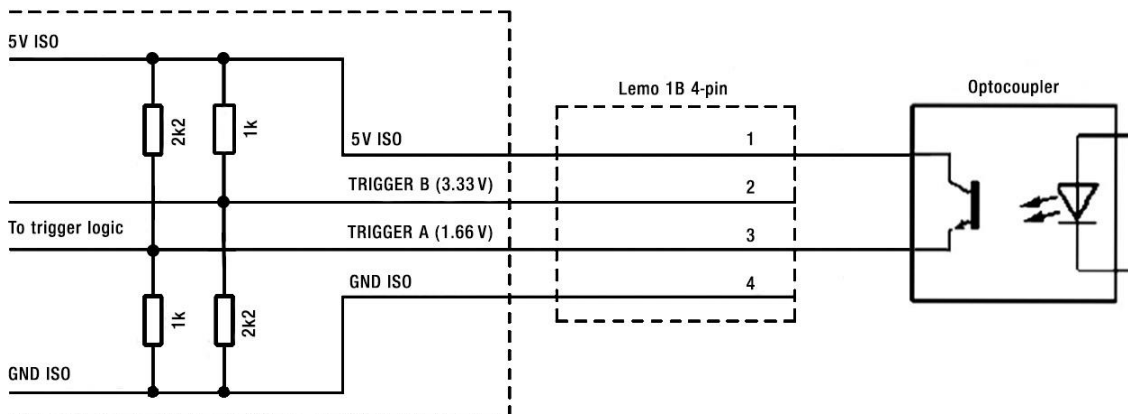

Figure 9: Schematic for optocoupler

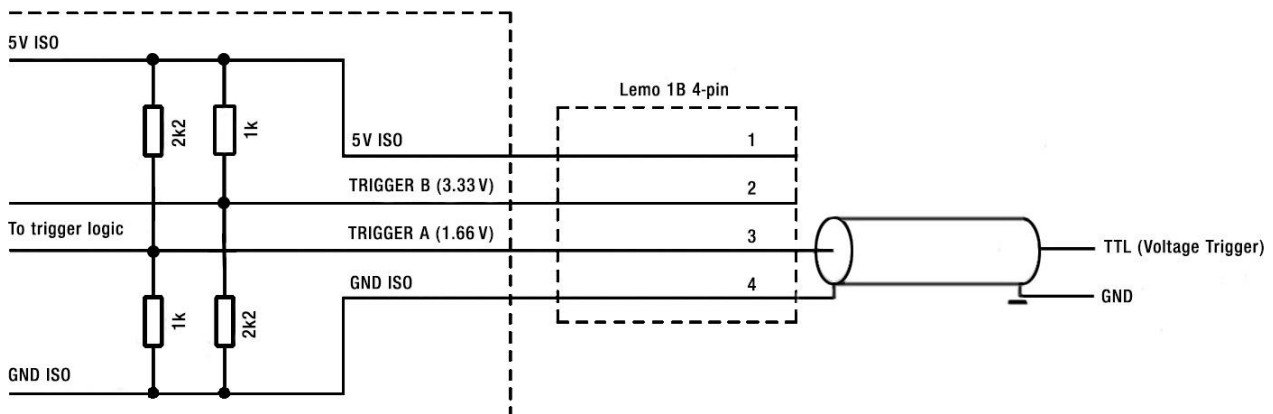

Figure 10: Schematic for TTL